

# TRES

1.62.161  
 1.62.161.30  
 1.62.161.60  
 1.62.161.70  
 1.62.161.80  
 1.62.161.90

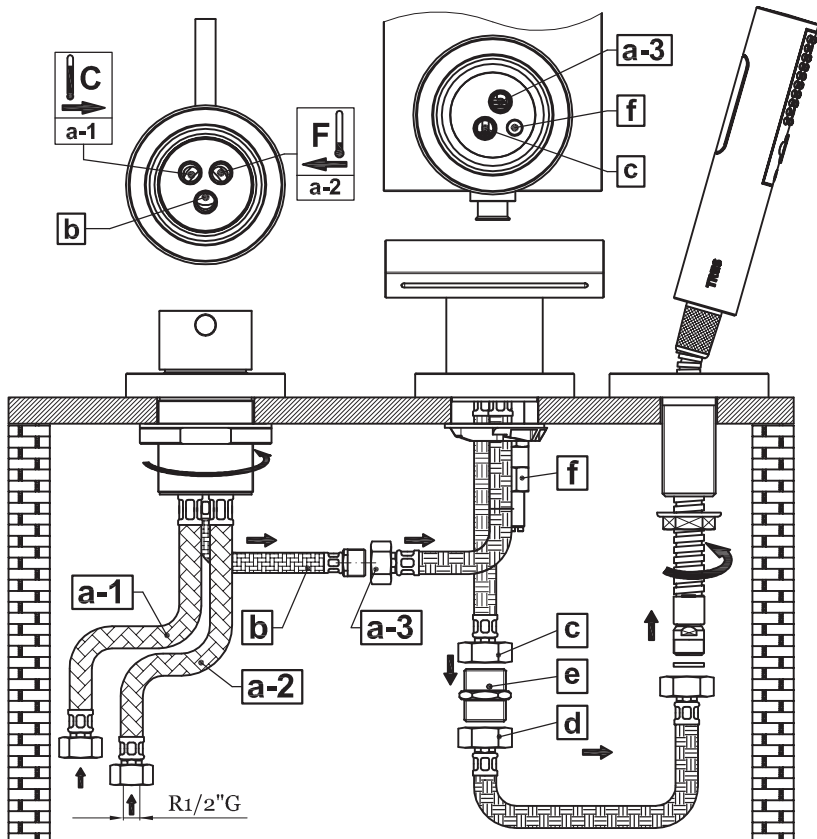
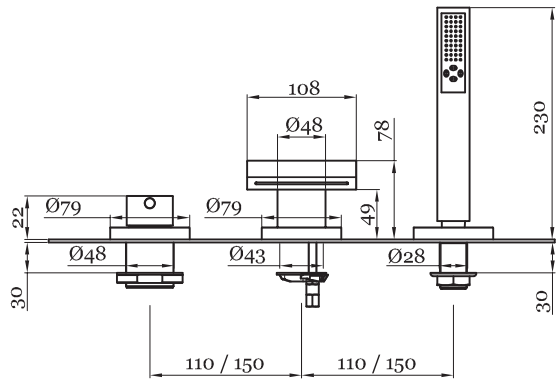
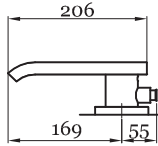

Ref. 1762381000 • ed. 11-2009

El incumplimiento de estas instrucciones exime de toda responsabilidad a Tres grifería · L'incompliment d'aquestes instruccions eximeix de tota responsabilitat a Tres grifería · Le non-respect de ces instructions dégage Tres grifería de toute responsabilité · Die missachtung dieser anweisungen befreit Tres grifería von jeglicher haftung · L'inadempimento delle presenti indicazioni esonera Tres grifería da qualsiasi responsabilità · The non-fulfilment of these instructions shall exempt Tres grifería from all and any liability · Nieprzestrzeganie niniejszych instrukcji zwalnia firmę Res grifería z wszelkiej odpowiedzialności · O incumprimento destas instruções isenta a Tres grifería de qualquer responsabilidade

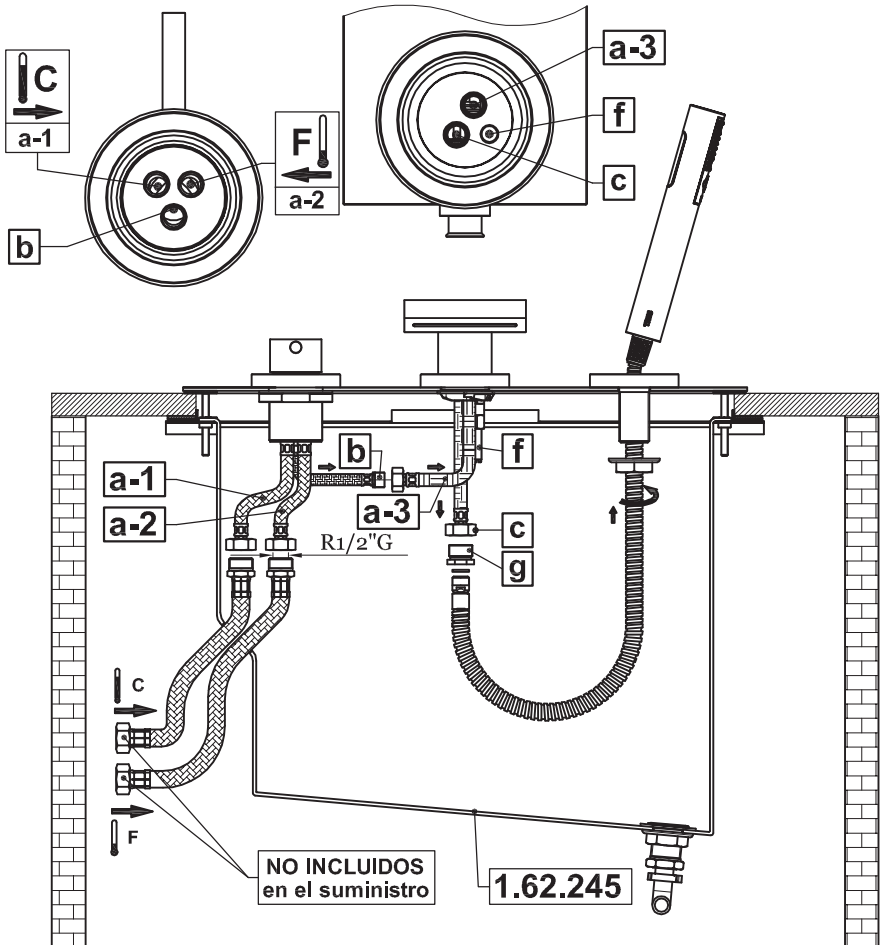
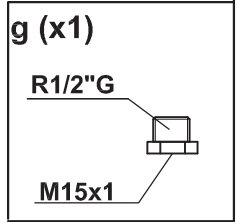
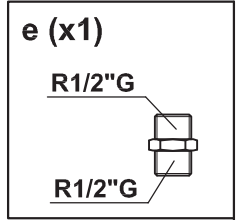
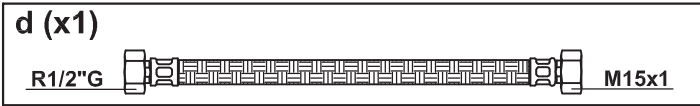
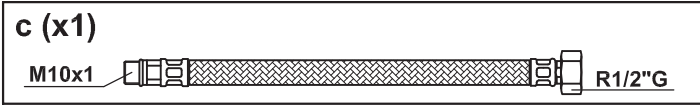
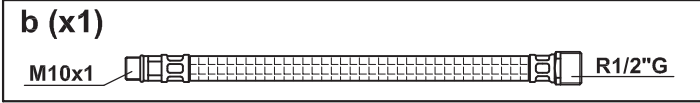
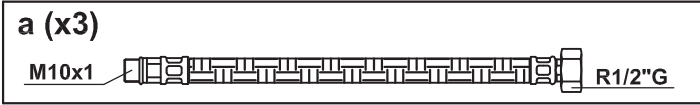

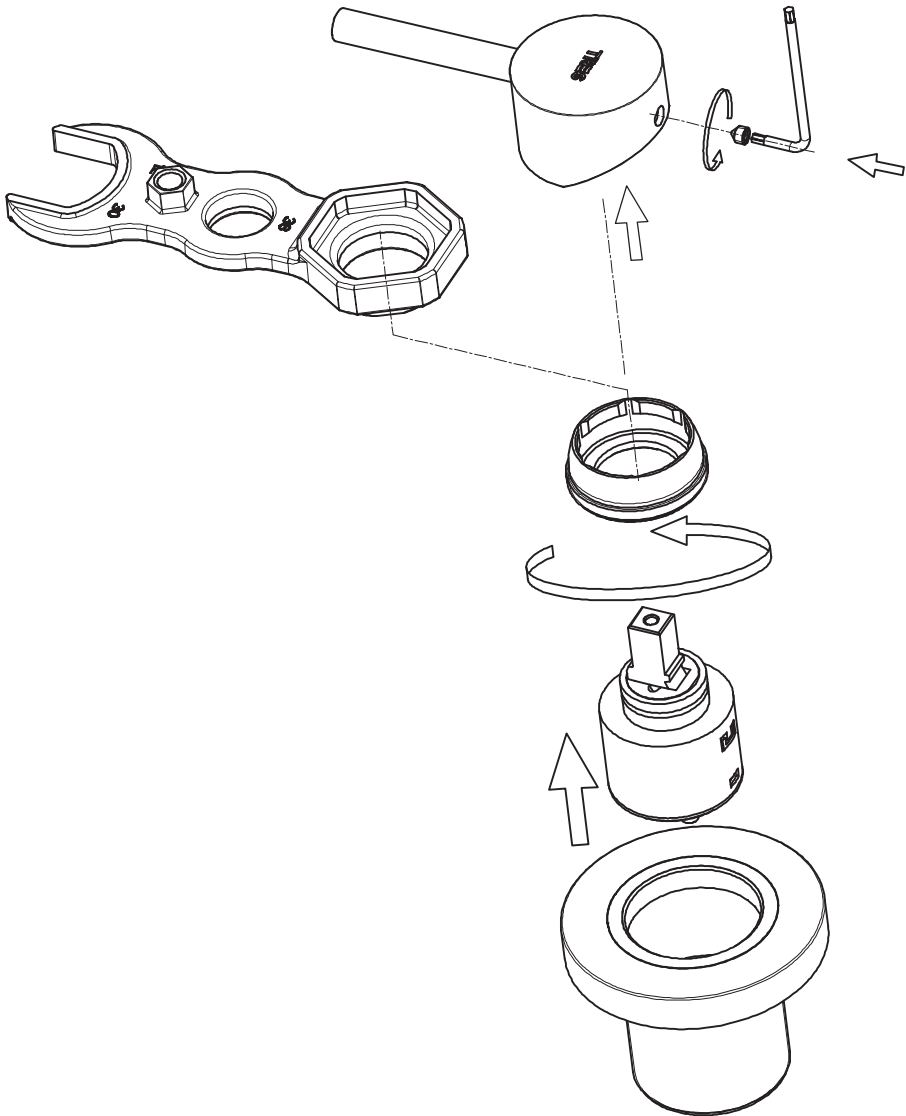
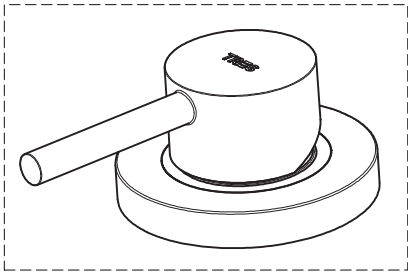

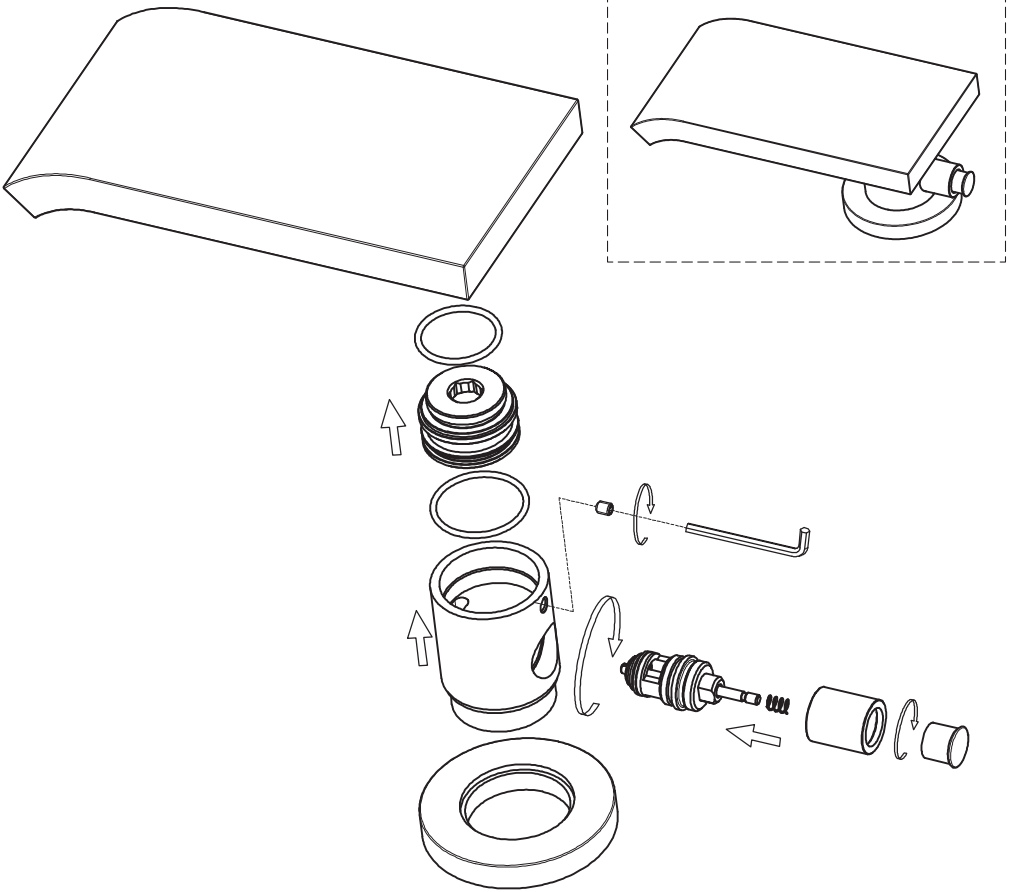

LIMPIEZA • NETEJA • NETTOYAGE • REINIGUNG • REINIGING • PULIZIA •  
 ČIŠTĚNÍ • CLEANING • CZYSZCZENIE • LIMPEZA • ЧИСТКА

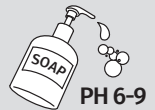

**TRES**

TRES COMERCIAL, SA | C/ Penedès, 16-26 · Zona Industrial, Sector A · 08759 Vallirana  
 comercialtres@tresgriferia.com · (+34) 93 683 40 27 · www.tresgriferia.com